

## Cisco ASR 1000 Series Routers Components

---

The Cisco ASR 1000 Series Routers contain the following components:

- [Cisco ASR 1000 Series Route Processor 1, page 2-1](#)
- [Cisco ASR 1000 Series Embedded Services Processor, page 2-8](#)
- [Cisco ASR 1000 Series SPA Interface Processor, page 2-10](#)
- [Cisco ASR 1000 Series Router Power Supplies, page 2-14](#)

**Note**

---

Throughout this document, the term slot refers to a Cisco ASR 1000 Series Router chassis slot. The Cisco ASR 1000 Series Route Processor 1, Cisco ASR 1000 Series Embedded Services Processor, and Cisco ASR 1000 Series SPA Interface Processor, and power supplies plug into these slots. SPAs plug into SIP bays.

---

### Cisco ASR 1000 Series Route Processor 1

The Cisco ASR 1000 Series Route Processor 1 (RP1) is the central network clocking card and is responsible for:

- Cisco ASR 1000 Series Routers field-replaceable unit (FRU) online insertion and removal (OIR).
- Selection of the active Cisco ASR 1000 Series Route Processor 1 and the Cisco ASR 1000 Series Embedded Services Processor and notification of the Cisco ASR 1000 Series SPA Interface Processor of these events.
- All the control processors communicating and performing packet processing on packets punted to it by the Cisco ASR 1000 Series Embedded Services Processor (ESP).

Specific system tasks performed by the Cisco ASR 1000 Series Route Processor 1 including the following:

- Runs the router control plane, including network control packets, and connection setup
- User interfaces: 10/100/1000 Management Ethernet, CON/AUX, USB
- Active and standby Cisco ASR 1000 Series Route Processor 1 and Cisco ASR 1000 Series Embedded Services Processor master and standby synchronization (Tasks include switchover from failing master to standby.)
- Code storage, management, and upgrade

- Downloading operational code for SIPs and Cisco ASR 1000 Series Embedded Services Processor over Ethernet out of band channel (EOBC), which is used for communication between the control processors on the Cisco ASR 1000 Series Routers
- CLI, alarm, network management, logging, and statistics aggregation
- Chassis management
- Ethernet out-of-band management
- Punt path processing for packets not supported by the forward processor

## Cisco ASR 1000 Series Route Processor 1 Features

The Cisco ASR 1000 Series Route Processor 1 (RP1) is the route processor that receives and transmits all network packets through the active embedded services processor. The Cisco ASR 1000 Series RP1:

- Provides a configuration repository along with a hard disk drive (optionally a solid-state drive) for logging system statistics, records, events, errors, and dumps (for both the Cisco ASR 1006 Router and Cisco ASR 1004 Router).
- Provides the management interfaces of the platform including Dual Asynchronous Receiver/Transmitter (DUART) that is used for the CON serial ports and Ethernet (ENET) management ports, CLI, status indicators, BITS interface, reset switch, ACO switch, and USB ports for secure keys.
- Provides chassis management (environmental, online insertion and removal)
- Provides non-volatile storage for the system used as the image and configuration repository along with the logger for system statistics, records, events, errors, and dumps.
- Is responsible for the chassis management including activation and initialization of the other cards, selection or switchover of active versus standby cards, image management and distribution, logging facilities, distribution of user configuration information, and alarm control.
- Provides control signals and Ethernet out of band channel (EOBC) for the two Cisco ASR 1000 Series Embedded Services Processors and one other Cisco ASR 1000 Series Route Processor 1.
- Includes control signals for monitoring the health of power entry modules, shutting down the power and driving alarm relays located on the power entry modules.
- Has high power (500mA) or low power (100mA) USB devices supported on both ports.



---

**Note**

Cables coming off the front of the Cisco ASR 1000 Series Route Processor 1 utilize the chassis-level cable-management brackets provided on the chassis rack-mount brackets.

---

The Cisco ASR 1000 Series RP1 module consists of a front panel label for indicator and control functions and a separate label for the I/O connectors. The Cisco ASR 1000 Series RP1 model number labeling is located on the left card module handle. The module also contains card handles to assist in insertion or removal of the module.

Figure 2-1 shows the Cisco ASR 1000 Series RP1 faceplate for the Cisco ASR 1006 Router and ASR 1004 Router.

Figure 2-1 Cisco ASR Series 1000 RP1 Faceplate LEDs and Connectors

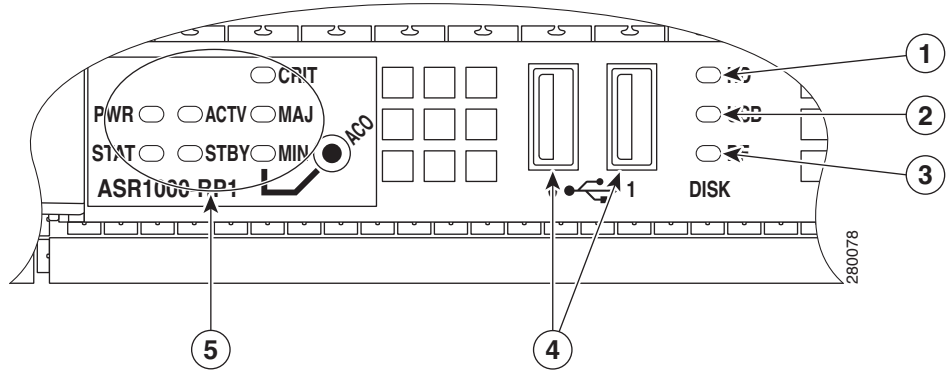

1	Internal hard drive LED	4	USB 0, USB 1 connector
2	External USB Flash LED	5	ASR1000 RP1 LEDs
3	Internal USB bootflash LED		

Figure 2-2 shows the Cisco ASR 1000 Series RP1 with faceplate connectors.

Figure 2-2 Cisco ASR Series 1000 RP1 Connectors

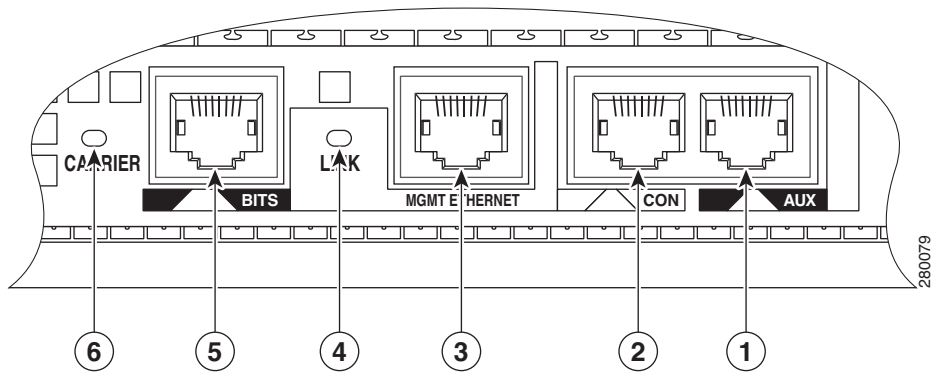

1	AUX connector	4	LINK LED
2	CON connector	5	BITS connector
3	MGMT Ethernet connector	6	CARRIER LED

Table 2-1 lists the Cisco ASR 1000 Series RP1 LEDs and behaviors.

**Table 2-1 Cisco ASR 1000 Series Route Processor 1 LEDs**

No.	LED Label	LED	Color —State	Behavior Description
1	PWR	Power	Solid green	All power requirements are within specification
			Off	Off, the router is in standby mode.
2	STAT	System status	Solid green	Cisco IOS has successfully booted.
			Yellow	ROMMON is running or when the Process Manager declares that a critical ASR 1000 Series RP1 process is not running
			Red	System failure or powering up.
3	ACTV	Active	Green	Lit when this is the active Cisco ASR 1000 Series RP1.
4	STBY	Standby	Yellow	Lit when this is the standby ASR1000 Series RP1.
5	CRIT*	Critical	Solid Red	Critical alarm indicator. For example: Ambient air temperature is above 60°C and will begin shutdown in 5 minutes.
6	MAJ*	Major	Solid Red	Major alarm indicator. For example: Ambient air temperature is beyond short term operating range of 55°C. System will shut down above 60°C.
7	MIN*	Minor	Amber	Minor alarm indicator. Ambient air temperature is beyond normal operating range of 40°C. For example: if the RP software determines that an unknown card has been installed or if the card has failed, the card can power it off or set a minor alarm.
8	DISK HD	Internal hard drive LED	Flashing Green	Active indicator.
			Off	No activity.
9	DISK USB	External USB Flash LED	Flashing Green	Active indicator.
			Off	No activity.
10	DISK BF	Internal USB bootflash LED	Flashing Green	Active indicator.
			Off	No activity.
11	CARRIER	LED	Off	Out of service or not configured.
			Solid Green	In frame and working properly.
			Amber	Fault of loop condition exists.

**Table 2-1 Cisco ASR 1000 Series Route Processor 1 LEDs (continued)**

No.	LED Label	LED	Color —State	Behavior Description
12	LINK	10/100/1000 RJ-45 Interface LED	Solid Green	Link with no activity.
			Flashing Green	Link with activity.
			Off	No link.

\* The type of alarm triggered is associated with the driver itself. For example, environmental alarms are tied to our environmental code, SONET alarms are tied to the sonet code, ENET to Ethernet.

Table 2-2 lists the Cisco ASR 1000 Series RP1 connectors and description.

**Table 2-2 Cisco ASR 1000 Series RP1 Connectors**

No.	Label	Type	Description
1	ACO	Alarm cutoff switch.	When you press this button, an interrupt is generated informing software that the audible alarm relays will be disabled. This interrupt generates to both processors.
2	0	USB connector 0	Side-by-side USB connector used with memory sticks or smart cards for secure key distribution
3	1	USB connector 1	Side-by-side USB connector used with memory sticks or smart cards for secure key distribution
4	BITS	RJ45 connector	Indicates BITS timing reference.
5	MGMT ETHERNET	One RJ-45 jack for copper Ethernet Management Port	The route processor has an ENET port with a RJ-45 connector to attach a management device or network for network management.
6	CON	One RJ-45 for CON	Console port used to connect to a terminal.
7	AUX	One RJ-45 for AUX	Auxiliary port used for remote management purposes.

The Cisco ASR 1000 Series RP1 meets the following requirements:

- Supports up to 4GB of ECC-protected memory with single-bit error correction and multi-bit error detection
- Supports On-board Failure Logging (OBFL) with 2MB of memory
- Supports the Cisco ASR 1000 Series Router system architecture, midplane, and the Cisco ASR 1006 Router
- Enhanced Serdes Interconnect (ESI) at 11.5 G bps.
- Gigabit Ethernet switches for EOBC communication and boot-up of the Cisco ASR 1000 Series SPA Interface (SIP) and Cisco ASR 1000 Series Embedded Services Processor.
- Runs Cisco IOS network control plane (routing protocol, connections setup)
- Cisco IOS punt packet forwarding
- Active/Standby Cisco ASR 1000 Series Route Processor 1 and Cisco ASR 1000 Series Embedded Services Processor selection

- Code storage and download operational code to Cisco ASR 1000 Series Embedded Services Processor and Cisco ASR 1000 Series SPA Interface (SIP)
- Bulk storage is 40G hard disk drive (SSD optional)
- I/O support: 2 Mb upgradeable BootRom, 1GB Embedded USB memory (EUSB)
- 512 MB embedded USB, 1GB on RP1 for Cisco ASR 1006 Router and ASR 1004 Router, and 8GB on Cisco ASR 1002 Router
- Front panel support: Console, 10/100/1000 Management port, and two USB ports

The two serial ports can run up to 115.2kbps with hardware flow control. One port is used as the CONSOLE port for secure configuration and status display. The default BAUD rate for the CONSOLE port should be set at 9600 BAUD. The console port is an asynchronous serial port; any devices connected to this port must be capable of asynchronous transmission.

The auxiliary port connects a modem or other DCE device (such as a CSU/DSU or other router) to allow remote service and dial backup access to the system. Both the console and auxiliary ports are asynchronous serial ports; any devices connected to these ports must be capable of asynchronous transmission. The AUX port is a diagnostics access port.

## Cisco Embedded ASR1000-RP1 for Cisco ASR 1002 Router

The route processor for the Cisco ASR 1002 Router supports all the typical customer management interfaces such as the Ethernet network management port and console and auxiliary serial ports of the route processor for the Cisco ASR 1006 and ASR 1004 routers. It also has LED status indicators, an RJ45 plug for a BITS timing reference and one USB ports which can be used with smart cards for secure key distribution or for image or configuration file updates. The route processor is part of the 12V power supply distribution and provides control for the power supplies.

The route processor for the Cisco ASR 1002 Router provides connection for one SPA bay and the circuitry for the a built-in 4xGE SPA.

The Cisco embedded ASR1000-RP1 for the Cisco ASR 1002 Router meets the requirements of route processor for the Cisco ASR 1006 and ASR 1004 routers in addition to these features:

- Supports up to 4GB of ECC protected field-replaceable memory with single-bit error correction and multi-bit error detection.
- eUSB based bulk storage supports 8GB on the Cisco ASR 1006 Router and the Cisco ASR 1004 Router. On the Cisco ASR 1002 Router, the bulk storage and eUSB bootflash are a single 8GB eUSB device (no hard disk or SSD).
- IO support: 2Mbyte upgradeable BootRom, minimum 512MB EUSB
- Front panel support: Console and Aux port, 10/100/1000 management port, one USB port, and Status and Alarm LEDs.
- Supports Stratum-3 network clocking with T1/E1 BITS interface or SPAs as timing sources.

Table 2-3 lists the Cisco embedded ASR1000-RP1 LEDs and behaviors.

**Table 2-3 Cisco Embedded ASR1000-RP1 LEDs**

LED Label	LED	Color —State	Behavior Description
PWR	Power	Green	All power requirements are within specification
STAT	System status	Green	Cisco IOS has successfully booted.
		Yellow	BootROM has successfully loaded.
		Red	System failure.
MIN	Minor	Amber	Minor alarm indicator.
MAJ	Major	Red	Major alarm indicator.
CRIT	Critical	Red	Critical alarm indicator.
BOOT	EUSB0 FLASH (BootDisk)	Flashing Green	Active indicator.
		Off	No activity.
CARRIER		Off	Out of service or not configured.
		Green	In frame and working properly.
		Amber	Fault or loop condition.
LINK	10/100 /1000 RJ-45 Interface LED	Green	Link with no activity.
		Flashing Green	Link with activity.
		Off	No link.
4 LEDs	Built-in SPA SFP port status	Off	Port is not enabled.
		Amber	Port enabled but there is a problem with the Ethernet link.
		Green	Port enabled, valid Ethernet link
PWR	SIP card power	Green	All SIP10 requirements are within specification.
STAT	SIP card status	Green	Only when the SPA drivers have started and are running and all critical processes are running
		Yellow	When ROMMON is running and during the download and boot of the operating system
		Red	A fault is detected or the card is powering up.

Table 2-4 lists the Cisco embedded ASR1000-RP1 connectors and description.

**Table 2-4 Cisco Embedded ASR1000-RP1 Connectors**

Label	Type	Description
BITS	RJ45 connector	Indicates BITS timing reference.
MGMT	One RJ-45 jack for copper Ethernet Management Ethernet Port	The route processor has an ENET port with a RJ-45 connector to attach a management device or network for network management.

**Table 2-4 Cisco Embedded ASR1000-RP1 Connectors (continued)**

Label	Type	Description
CON	One RJ-45 for CON	Console port used to connect to a terminal.
AUX	One RJ-45 for AUX	Auxiliary port used for remote management purposes.

Figure 2-3 shows a fully-loaded Cisco ASR 1002 Router.

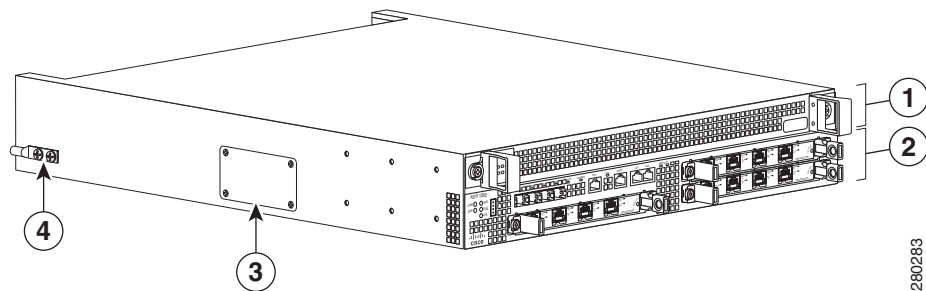
**Figure 2-3 Cisco ASR 1002 Router Route Front View**

1	FO slot	3	The eUSB panel door on the side of the Cisco ASR 1002 Router must not be opened. If there is a problem with eUSB flash card, the chassis should be returned.
2	R0 slot	4	Grounding stud

The Cisco ASR 1000 Series Route Processor for the Cisco ASR 1002 Router deviates from the other route processor in the following ways:

- No SATA hard drive supported. Bulk file storage is on a large fixed EUSB device (up to 8GB supported).
- No support for redundant route processors.
- Network clock changes. No second BITS clock input supported.
- The connector and mechanical support for one half height SPA bay is included.
- The LED order is from top to bottom on the route processor is MIN, MAJ, CRIT.

## Cisco ASR 1000 Series Embedded Services Processor

The Cisco ASR 1000 Series Embedded Services Processor (ESP) is based on the Cisco QuantumFlow Processor for next-generation forwarding and queuing. provides the centralized embedded services processor responsible for the bulk of the data plane processing tasks. All network traffic through the Cisco ASR1000 Series system flows through the Cisco ASR 1000 Series Embedded Services Processor.



The Cisco ASR 1000 Series Embedded Service Processors, Cisco ASR 1000-ESP5 and Cisco ASR1000-ESP10 provide two centralized forwarding-engine options for the Cisco ASR 1000 Series Aggregation Services Routers. The Cisco ASR 1000 Series ESPs:

- Are responsible for the data-plane processing tasks and all network traffic flows through them.
- Perform all baseline packet routing operations, including MAC classification, Layer 2 and Layer 3 forwarding, quality-of-service (QoS) classification, policing and shaping, security access control lists (ACLs), VPNs, load balancing, and NetFlow.
- Are responsible for features such as firewalls, intrusion prevention, Network Based Application Recognition (NBAR), Network Address Translation (NAT), and flexible pattern matching.

The 5-Gbps Cisco ASR 1000 Series ESP (ASR1000-ESP5) supports 5-Gbps bandwidth and is supported only on the Cisco ASR1002 Router chassis. The 10-Gbps Cisco ASR 1000 Series ESP supports 10-Gbps bandwidth, is supported on all Cisco ASR 1000 Series chassis.

The Cisco ASR 1000 Series Routers support the following ESPs:

- Cisco ASR 1000 Series ESP10—Supports forwarding performance with up to 8 Mpps with baseline features and bandwidth of 10Gbps. The Cisco ESP10 is located in:
  - Cisco ASR 1006 Router physical slots 3 and 4 and are labeled F0 and F1.
  - Cisco ASR 1004 Router physical slot 1 and is labeled F0.
  - Cisco ASR 1002 (which can use either the ESP10 or the ESP5; but Cisco ASR 1002 Router is the only chassis that supports Cisco ASR1000-ESP5)
- Cisco ASR 1000 Series ESP5—Supports forwarding performance with up to 4 Mpps with baseline features and bandwidth of 5Gbps. The Cisco ASR1000-ESP5 is in slot 1 and is labeled F0 in the Cisco ASR 1002 Router.

The Cisco ASR 1000 Series Embedded Services Processor consists of three main elements:

- Embedded services processor for packet processing and queueing and scheduling
- Data plane interconnect
- Forwarding Engine Control Processor (FECP) (located on the Cisco ASR Series Embedded Services Processor)

The forwarding processors for all initial Cisco ASR 1000 Series Embedded Services Processors are based on a common highly-programmable network Cisco QuantumFlow Processor (packet processing).

The Cisco ASR 1000 Series Embedded Services Processor (ESP) consists of a front panel label for indicator and control functions. The Cisco ASR 1000 Series Embedded Services Processor model number labeling is located on the left card module handle. The module also contains card handles to assist in insertion or removal of the module.

Figure 2-4 shows the Cisco ASR 1000 Series Embedded Services Processor (ESP10) LEDs on the front panel.

Figure 2-4 Cisco ASR1000-ESP10 Faceplate LEDs

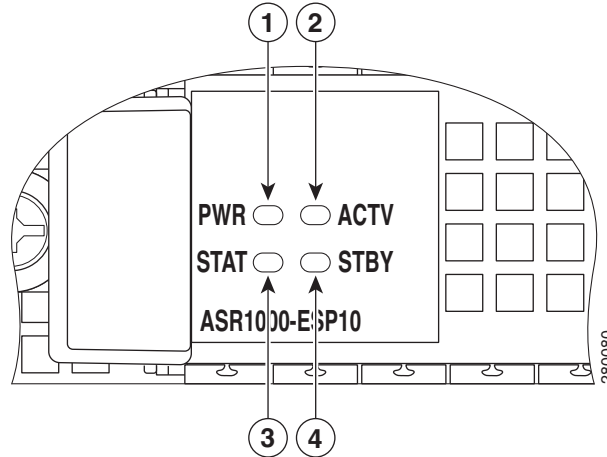

1	Power LED	3	Status LED
2	Active LED	4	Standby LED

Table 2-5 lists the Cisco ASR1000-ESP5 or ASR1000-ESP10 LEDs and behaviors.

Table 2-5 Cisco ASR1000-ESP5 or ESP-10 Processor LEDs for the Cisco ASR 1002 Router

	LED Label	LED	Color	In the Power Up State - Behavior Description
1	PWR	Power	Solid green	All power supplies are within operational limits.
			Off	Off, the router is in standby mode.
3	STAT	STATUS	Green	Code has successfully downloaded and is operational.
			Yellow	BOOT ROM has successfully loaded.
			Red	Not booted.
2	ACTV	Active	Green	The embedded services processor is green when active.
4	STBY	Standby	None	Will always be off.

## Cisco ASR 1000 Series SPA Interface Processor

This section describes the SPA interface processor for the Cisco ASR 1006 Router, Cisco ASR 1004 Router and the Cisco ASR 1002 Router.

The Cisco ASR 1000 Series SPA Interface Processor for the Cisco ASR 1006 and Cisco ASR 1004 routers:

- Is a carrier card that inserts into a router slot like a line card.

- Contains one or more subslots which house one or more shared port adapters.
- Supports online insertion and removal (OIR) with SPAs inserted in the subslots. SPAs also support OIR and can be inserted or removed independently from the SIP.

This section describes the Cisco ASR 1000 Series SPA Interface (SIP) components and subslot identification.

Figure 2-5 shows the Cisco ASR 1000 Series SPA Interface (SIP) module.

**Figure 2-5 Cisco ASR 1000 Series SIP Faceplate**

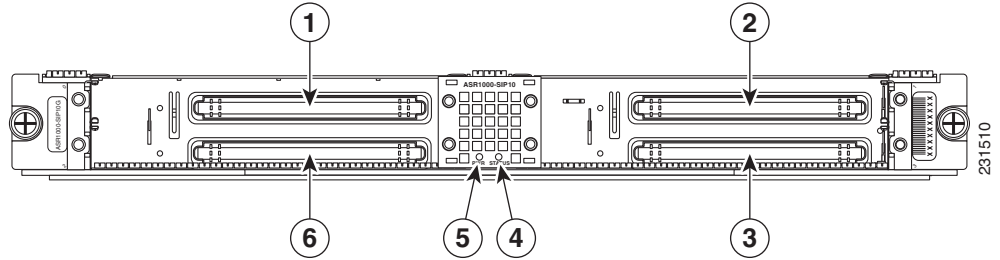

<b>1</b>	SPA subslot 0	<b>3</b>	SPA subslot 3
<b>2</b>	SPA subslot 1	<b>4</b>	SPA subslot 2

Figure 2-6 shows the LEDs on the Cisco ASR1000-SIP 10.

**Figure 2-6 Cisco ASR1000-SIP10 SPA Interface Processor LEDs**

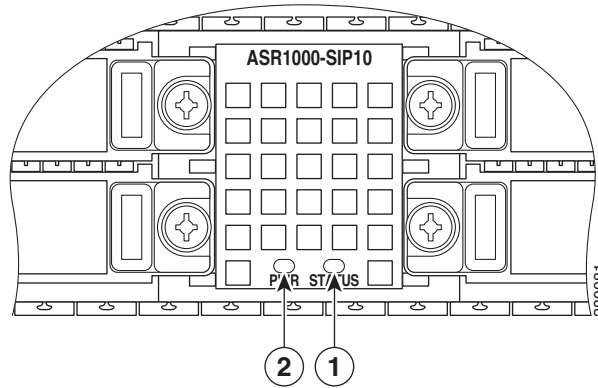

<b>1</b>	PWR LED	<b>2</b>	Status LED
----------	---------	----------	------------

Table 2-6 describes the Cisco ASR 1000 Series SIP10 LEDs on the front panel.

**Table 2-6 Cisco ASR1000-SIP10 LEDs**

No.	LED Label	LED	Color—State	Behavior Description
1	PWR	Power status indicates the status of the power supply	Off	Cisco ASR 1000 Series SIP is powered off
			Green	Cisco ASR 1000 Series SIP is powered on
2	STATUS	Indicates the current state of the Cisco ASR 1000 Series SPA Interface (SIP).	Red	The Cisco ASR 1000 Series SPA Interface Processor has encountered an error
			Yellow	Lit when the Cisco ASR 1000 Series SIP is loading
			Green	The SPA drivers have started and are running and all critical processes are running (as determined by the Cisco ASR 1000 Series SPA Interface (SIP) Process Manager).

The Cisco ASR 1002 Router supports a built-in 4xGE SPA and three half-height SPAs (one half-height and one full height SPA). The Cisco embedded ASR1000-SIP10 on the Cisco ASR 1002 Router also functions as the base board for the Cisco embedded ASR1000-RP1. The Cisco 1002 Router has one slot for FP0 with three subslots for SPAs, subslots 1 - 3.

## Shared Port Adapters

A shared port adapter is a modular type of port adapter that inserts into a subslot of a compatible SIP to provide network connectivity and increased interface port density. The Cisco ASR 1000 Series SPA Interface (SIP) provides an aggregation function for SPAs.

In the Cisco ASR 1006 Router, the Cisco ASR1000 Series SIP supports:

- 4 HH (¼ rate or full rate or combination)
- 2 FH (¼ rate or full rate or combination) SPAs with up to 32 ports per SPA
- 2 HH and 1 FH Combination that does not exceed 64 ports

Figure 2-7 shows the slot numbering for the shared port adapters on the Cisco ASR 1000 Series SPA Interface for the Cisco ASR 1006 Router.

**Figure 2-7 Cisco ASR 1000 Series SPA Interface Subslot Numbering for Cisco ASR 1006 Router**

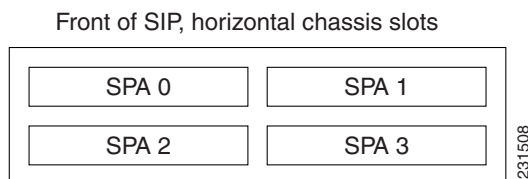

In the Cisco ASR 1004 Router, the Cisco ASR1000 Series SIP supports:

- Four half height (¼ rate or full rate or combination)
- Two full height (¼ rate or full rate or combination) SPAs with up to 32 ports per SPA

The slot numbering for the SPAs in the Cisco ASR 1004 Router is the same as in the Cisco ASR 1006 Router.

In the Cisco ASR 1002 Router, the Cisco embedded ASR1000-SIP10 supports:

- Three removable half height SPAs on Bay 1, 2, and 3
- The fourth SPA which is a built-in 4xGE SPA on Bay 0 located on the Cisco ASR 1000 Series RP1



**Note** The shared port adapters on the Cisco embedded ASR1000-SIP10 support online insertion and removal. However, the Cisco embedded ASR1000-SIP10 in the Cisco ASR 1002 Router is built into the chassis and is not a field-replaceable unit and does not support online insertion and removal.

Figure 2-8 shows the slot numbering for the shared port adapters on the Cisco ASR 1000 Series SPA Interface for the Cisco ASR 1002 Router.

**Figure 2-8 Cisco Embedded ASR1000-SIP10 Interface Subslot Numbering**

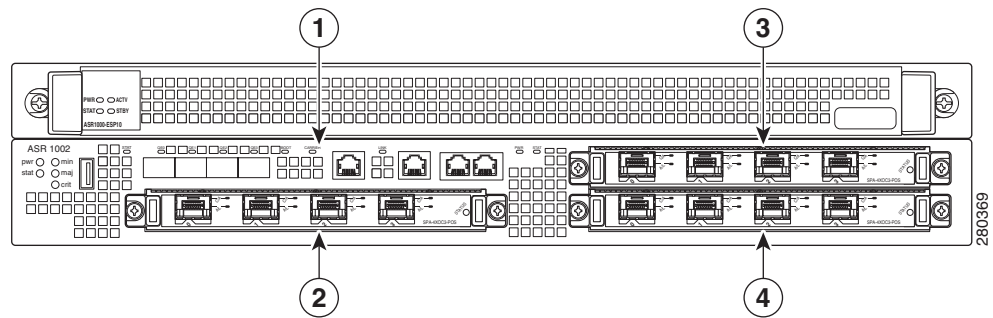

<b>1</b>	Cisco embedded ASR1000-RP1 subslot 0	<b>3</b>	SPA subslot 1
<b>2</b>	SPA subslot 2	<b>4</b>	SPA subslot 3

The Cisco embedded ASR1000-SIP10 supports one built-in 4xGE SPA and three half height SPAs in any one of the following configurations:

- Built-in 4xGE SPA in bay 0 and three half height SPAs in bay 1, 2, 3.
- Built-in 4xGE SPA in bay 0, one half height SPA in bay 2, and one full height SPA in bay 1.

The Cisco ASR 1000 Series SPA interface processor houses SPA bay 2 and SPA bay 3. SPA bay 0 and SPA bay 1 are physically located on Cisco embedded ASR1000-RP1. A portion of the Cisco embedded ASR1000-RP1 is reserved to provide connectivity between SPA bay 1 and the Cisco embedded ASR1000-SIP10.

For information about specifying SIP subslot location for a SPA and specifying slot location for a SIP, see the *Cisco Aggregation Services Router 1000 Series SIP and SPA Installation Guide*.

# Cisco ASR 1000 Series Router Power Supplies

All Cisco ASR 1000 Series Router configurations support AC and DC power supply options. The modular chassis configurations support the installation of two power supplies for redundancy. When an external power supply fails or is removed, the other power supply provides power requirements for the chassis.

You are required to always have two power supplies installed in the chassis to insure sufficient cooling for the box. The system fans are inside the power supply unit and must spin for cooling. No Cisco ASR 1000 Series Router will operate for more than two to three minutes without two power supplies installed. Since all the system fans can be powered by one power supply, it is not required for the second power supply unit to be powered on, but it must be installed. Cisco IOS software specifically looks for two power supplies in the chassis and will automatically initiate a shutdown if only one power supply is detected.

This section contains the following topics:

- [Power Supply Requirements for All Cisco ASR 1000 Series Routers, page 2-14](#)
- [Power Supplies for Cisco ASR 1006 Router, page 2-16](#)
- [Power Supplies for Cisco ASR 1004 Router, page 2-21](#)
- [Power Supplies for Cisco ASR 1002 Router, page 2-26](#)

## Power Supply Requirements for All Cisco ASR 1000 Series Routers

This section contains power supply specifications for the Cisco ASR 1006, ASR 1004, and ASR 1002 routers. The following topics are covered:

- DC power supply input ratings and circuit breaker specifications
  - Maximum and minimum Amps for the branch circuit breakers
  - Maximum and minimum size of the AWG wire required for each circuit breaker.
- AC and DC power supply types
- AC and DC power supply ratings

## DC Power System Input Requirements for Cisco ASR 1000 Series Routers

The DC power supply for the Cisco ASR 1006, ASR 1004, and ASR 1002 routers operate at specifications. shows the common input ranges and circuit breaker requirements.

**Table 2-7 Cisco ASR 1000 Series Router DC Power Supply System Input Requirements**

Cisco ASR 1000 Series Router DC Power Supply	System Input Rating (Amps)	Circuit Breaker Amps		AWG # Wire	
		Minimum	Maximum	Minimum	Maximum
Cisco ASR 1006	40	Always 50		Always AWG #6 wire	
Cisco ASR 1004	24	30	40	10	8
Cisco ASR 1002	16	20	30	12	10

For example, the Cisco ASR 1002 Router DC power supply, with 16 Amp input rating must use an AWG #12 gauge wire for a 20Amp circuit breaker and an AWG #10 gauge wire for a 30Amp circuit breaker.



### Note

All Cisco ASR 1000 Series Router AC power supplies require a 20 AMP circuit breaker.

## AC and DC Power Supply Types

The AC and DC power supplies for the Cisco ASR 1000 Series Routers support different types of power supply switches. [Table 2-8](#) defines which power supplies the Cisco ASR 1000 Series routers support (a Standby or an On/Off switch).

**Table 2-8 Cisco ASR 1000 Series Routers AC and DC Power Supply Switches**

Switch Type Supported	Symbol	Cisco ASR 1000 Series Router Power Supply
On/Off circuit	I/O	ASR 1006 DC ASR 1004 DC ASR 1002 AC
Standby switch	A broken circle with a vertical line through the top of it	ASR 1006 AC ASR 1004 AC ASR 1002 DC

## AC and DC System Power Ratings

[Table 2-9](#) lists AC and DC power supply system rating requirements for all Cisco ASR 1000 Series Routers.

**Table 2-9 AC and DC Power Supply System Rating Specifications for the Cisco ASR 1000 Series Routers**

Description	Specification
Power supply declared ratings	AC = 100-240 VAC DC = -48/ -60 VDC
Nominal line frequency rating	50/60 Hz

## Power Supplies for Cisco ASR 1006 Router

The Cisco ASR 1006 Router can support up to 1200W output (AC and DC input). The 1200W power supply module consists of either an AC or DC input and 1200 watt output closed frame power supply with two DC voltage outputs: 12V and 3.3V.

Each power supply module contains three internal fan modules and provides the forced air cooling for the chassis. These power supply modules contain a monitor circuit to determine the status of fan speed and operation along with LED status indicating fan errors.

The system temperature operation is 0 to 40C normal and -5C to +55C.

- AC System—AC power input is an IEC 320-type power inlet, 20A service connector. The AC input side contains a front panel with provisions for mounting screw, built in handle to extract the power supply, three status LEDs, and fans for power supply and system cooling.
- DC System—Two-position terminal block-style connector, with labeled connections for - (-48/60 V input) and + (-48/60 V Return). The DC input side contains a front panel with provisions for mounting screw, built in handle to extract the power supply, three status LEDs, and fans for power supply and system cooling.

See [Appendix A, “Cisco ASR 1000 Series Routers Specifications.”](#) for detailed power supply specifications.



### Warning

**This product relies on the building’s installation for short-circuit (overcurrent) protection. Ensure that the protective device is rated not greater than: AC power supplies for the Cisco Aggregation Services Routers: 120 VAC, 20A U.S. maximum. DC power supplies for the Cisco ASR 1006 Router: 50A U.S. maximum; Cisco ASR 1004 Router: 40A U.S. maximum; Cisco ASR 1002 Router: 30A U.S. maximum.**  
Statement 1005

## AC Power Supply LEDs and Connector for Cisco ASR 1006

This section provides information about the AC power supplies on the rear of the Cisco ASR 1006 Router. The power supply module contains three fans mounted in the power supply module. A total of six fans are used to cool the ASR 1006 system and power supply. The airflow direction is front to back.

Power supply modules with internal fan modules install into the rear of the chassis. These modules contain integral handles to ease installation and removal (no insertion or extraction levers are provided). A single blind mate connector located on the inlet side of these modules mates with a connector mounted on back side of the midplane.

Guide pins located at the rear of these modules help center locate the modules and reduce stress to the midplane and module mounted connectors. Four captive screws (tool operated latches) are provided on the modules face plate (chassis rear) to secure these modules into the chassis.



Figure 2-9 shows the AC power supplies at the rear of the Cisco ASR 1006 Router. The Cisco ASR 1006 Router supports up to two power supplies. The power supply LEDs and connectors on the rear of the chassis are described in Table 2-10.

Figure 2-9 Cisco ASR 1006 Router AC Power Supply

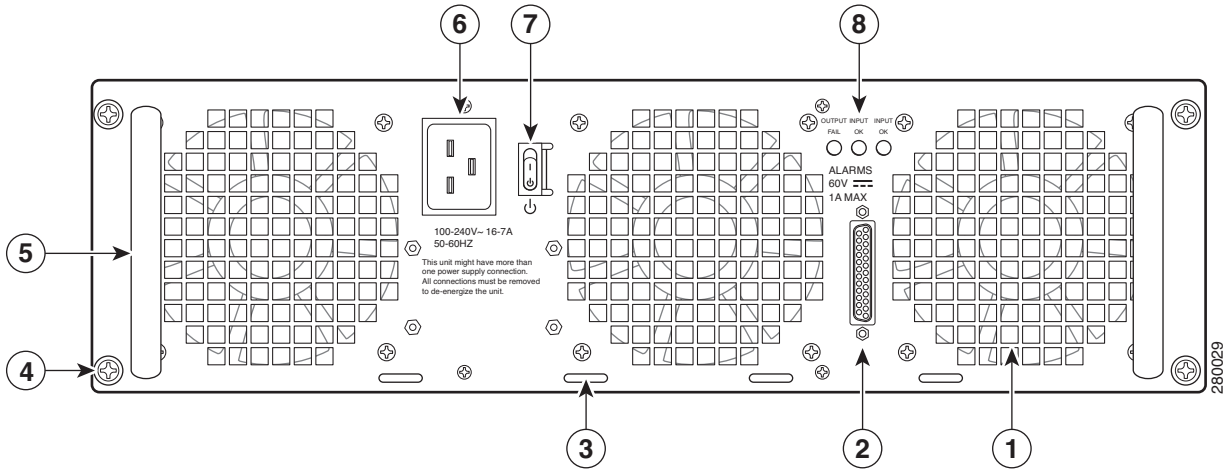

1	AC power supply fan	5	AC power supply handle
2	DB-25 alarm connector	6	AC power inlet
3	Tie-wrap tab	7	AC power supply Standby switch
4	AC power supply captive screw	8	AC power supply LEDs

Figure 2-10 shows the AC power supplies LEDs and DB-25 alarm connector.

Figure 2-10 Cisco ASR 1006 Router AC Power Supply LEDs and DB-25 Alarm Connector

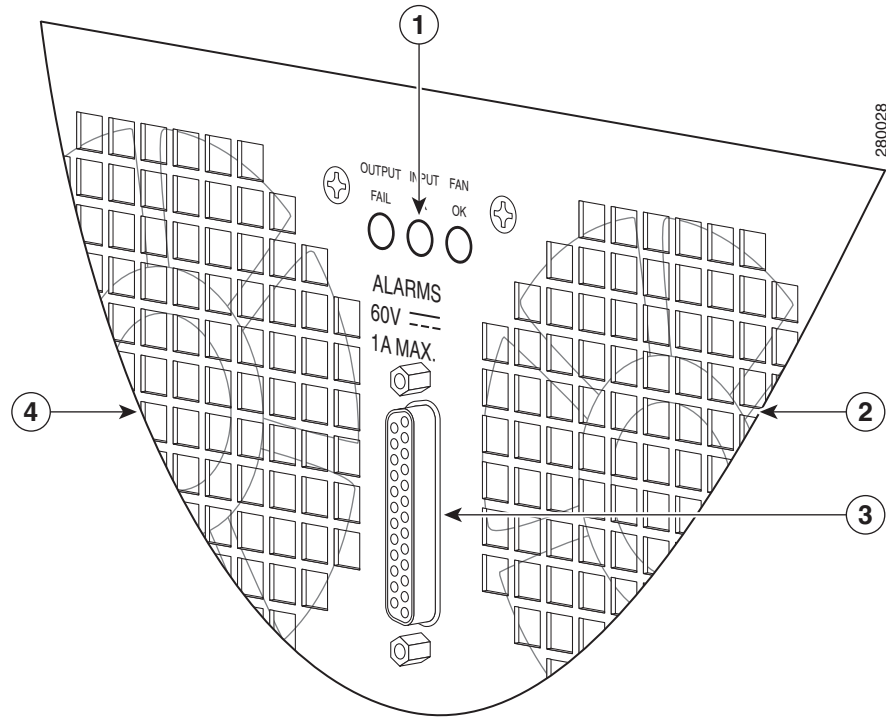

<b>1</b>	AC power supply LEDs	<b>3</b>	DB-25 alarm connector
<b>2</b>	AC power supply fan	<b>4</b>	AC power supply fan

Table 2-10 describes the AC power supply LEDs on the Cisco ASR 1006 Router.

Table 2-10 Cisco ASR 1006 Router AC Power Supply LEDs and Connector

LED Label	LED	Color	Description
INPUT OK	Power supply activity	Green	LED illuminates green to signal that the AC power supply input voltage is greater than 85V.
		None	If LED is not illuminated, then the AC input voltage is less than 70V or the power supply is turned off. For an AC input voltage between 70V and 85V, the INPUT OK LED can be either on, off, or flashing

LED Label	LED	Color	Description
FAN OK	Bi-color LED indicates fan status	Green	LED illuminates green when all fans are operational.
		Red	The LED illuminates red when a fan failure is detected.
OUTPUT FAIL	Power supply activity	Red	LED is red and turned off to signal that the AC output voltages are within the normal operating range; output voltage between the minimum and maximum limits will not create an output fail alarm, and output voltages below the minimum or above the maximum will create an output fail alarm.  When you turn the power supply on, the red LED is illuminated for two to three seconds for testing LED operation before going off.

## DC Power Supply LEDs and Connectors for Cisco ASR 1006

This section provides information about the DC power supplies on the rear of the Cisco ASR 1006 Router. The maximum branch circuit for the DC power supply module is 60A and the minimum is 50A.

The DC power supply operates within specification from –48 VDC to –60 VDC continuously. The Cisco ASR 1006 Router has two of the same type power supplies in power supply slot 0 and power supply slot 1. The power supply slot numbers are on the left side of the chassis and the power supplies are located on the floor of the chassis.

The DC input connector is a terminal block style that supports a AWG #6 wire. The terminal block is compliant to all safety agencies and electrical requirements of the supply. Use the tie wraps to dress the input cable wires. There are three tie wrap tabs on the power supply.

The terminal block accepts two double-hole lugs, one for –48V input and another for –48V RTN. A plastic cover fits over the terminal block to prevent accidental contact. See [Figure 5-18](#).



### Note

The studs on the terminal block are similar to the safety ground device on the side of the Cisco ASR 1006 Router. For information on the safety ground lug on the side of the chassis.

The unit requires a power switch circuit breaker to serve as the main disconnect for the DC input to the power supply. The circuit breaker meets international safety requirements and supports 80 VDC and has a current rating of 50 A. The power supply unit is secured into the system chassis with four captive screws mounted on the faceplate.

[Figure 2-11](#) shows the DC power supplies at the rear of the Cisco ASR 1006 Router. The Cisco ASR 1006 Router supports up to two power supplies. The power supply LEDs and connectors on the rear of the chassis are described in the [Table 2-11](#).

Figure 2-11 Cisco ASR 1006 Router DC Power Supply

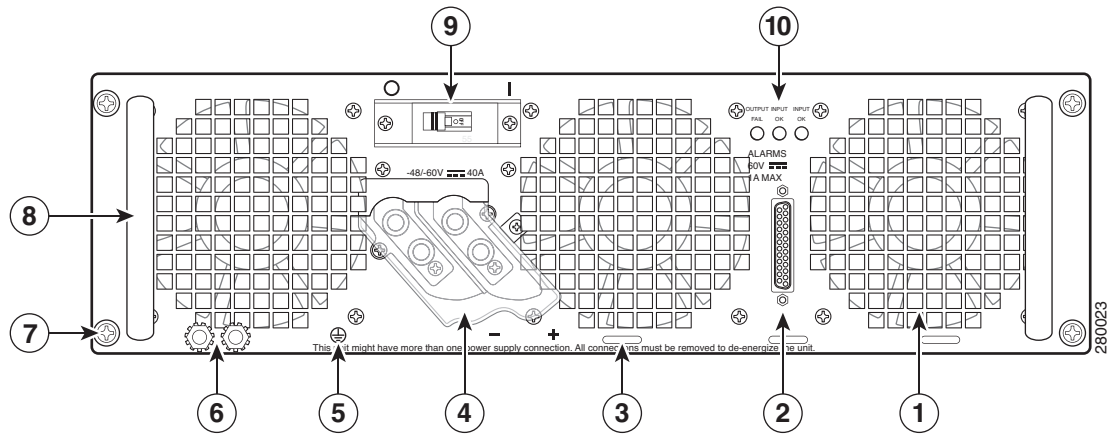

1	Fans	6	DC Power supply earth ground lugs
2	DB-25 alarm connector	7	DC Power supply captive screws
3	Tie-wrap tabs	8	DC Power supply handle
4	DC power supply terminal and plastic cover	9	DC power supply On (I) /Off (O) switch
5	Earth grounding symbol	10	DC power supply LEDs

Table 2-11 describes the LEDs on the Cisco ASR 1006 Router DC power supply.

Table 2-11 Cisco ASR 1006 Router DC Power Supply LEDs

LED Label	LED	Color	Description
INPUT OK	A bi-color LED indicates presence of input voltage	Green	LED illuminates green to signal that the DC power supply input voltage is greater than $-43.5\text{VDC}$ at turn-on and remains green down to $-39\text{VDC}$ .
		Amber	The LED illuminates amber when the input voltage (falls below $-39\text{VDC}$ ) and indicates that there is still a voltage present (voltage on the terminal block). The LED remains amber and is active to around $20\text{V} \pm 5\text{V}$ . The LED is not illuminated if the input is below $-15\text{V}$ .
FAN OK	A bi-color LED indicates power supply fan status	Green	The LED illuminates green when all fans are operational.
		Red	The LED illuminates red when a fan failure is detected.
OUTPUT FAIL	Power supply activity	Red	When the LED is off, it signals that the DC output voltage are within the normal operating range. Output voltage between the minimum and maximum limits will not create an output fail alarm, and output voltages below the minimum or above the maximum will create an Output Fail alarm.  When you turn the power supply on, the red LED illuminates for two to three seconds to test LED operation before going off.

## AC/DC Power System Output for Cisco ASR 1006

The power supply output tolerance is defined in [Table 2-12](#) under all combinations of line variation. Total system consumption per power supply should not exceed 1200 W.

**Table 2-12 Cisco ASR 1006 Router Power System Output Voltage and Current**

Output Voltage	+12 VDC	+3.3 V
Minimum	11.80 VDC	3.20 VDC
Nominal	12.00 VDC	3.30 VDC
Maximum	12.20 VDC	3.40 VDC
Output Current		
Minimum	2.80 A	0.10 A
Maximum	101.7 A	3.125 A

## Power Supplies for Cisco ASR 1004 Router

The Cisco ASR 1004 Router can support up to 735 W output (AC and DC input). The 735W power supply module consists of either an AC or DC input with two DC voltage outputs: 12V and 3.3V.

Each power supply module contains three internal fan modules and provides the forced air cooling for the chassis. These power supply modules contain a monitor circuit to determine the status of fan speed and operation along with LED status indicating fan errors.

The system temperature operation is 0 to 40C and –5C to +55C.

- AC System—AC power input is an IEC 320-type power inlet, 15A service connector. The AC input side contains a front panel with provisions for mounting screw, built in handle to remove the power supply, three status LEDs, and fans for power supply and system cooling.
- DC System—Three-position terminal block-style connector, with labeled connections for - (–48/60 V input) and + (–48/60 V Return) and GND (earth ground symbol). The DC input side contains a front panel with provisions for mounting screw, built in handle to extract the power supply, three status LEDs, and fans for power supply and system cooling.

See [Appendix A, “Cisco ASR 1000 Series Routers Specifications.”](#) for detailed power supply specifications.



### Warning

**This product relies on the building’s installation for short-circuit (overcurrent) protection. Ensure that the protective device is rated not greater than: AC power supplies for the Cisco Aggregation Services Routers: 120 VAC, 20A U.S. maximum. DC power supplies for the Cisco ASR 1006 Router: 50A U.S. maximum; Cisco ASR 1004 Router: 40A U.S. maximum; Cisco ASR 1002 Router: 30A U.S. maximum.**  
Statement 1005

## Cisco ASR 1004 AC Power Supply

This section provides information about the AC power supplies on the rear of the Cisco ASR 1004 Router. The power supply module contains three fans mounted in the power supply module. A total of six fans are used to cool the ASR 1004 system and power supply. The airflow direction is front to back.

Power supply modules with internal fan modules install into the rear of the chassis. These modules contain handles to ease installation and removal. The AC power supply has a front panel mounted switch that powers on and off the power supply. This switch will not disconnect the AC line, but will act only as a standby switch to the power supply. The front panel includes a mechanical guard to prevent the standby switch from being tripped due to accidental contact.

Guide pins located at the rear of these modules help center locate the modules and reduce stress to the midplane and module mounted connectors. Four captive screws (tool operated latches) are provided on the modules face plate (chassis rear) to secure these modules into the chassis.

## Cisco ASR 1004 AC Power Supply LEDs and Connector

Figure 2-12 shows the AC power supplies at the rear of the Cisco ASR 1004 Router. The Cisco ASR 1004 Router supports up to two power supplies. The power supply LEDs and connectors on the rear of the chassis are described in Table 2-13.

Figure 2-12 Cisco ASR 1004 Router AC Power Supply

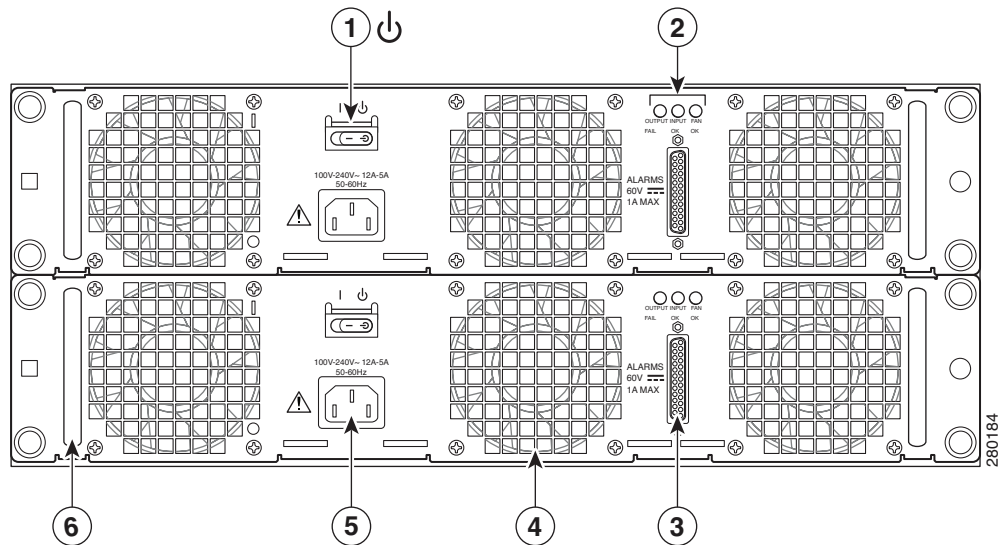

1	AC power supply Standby switch (standby symbol is a broken circle with a vertical line through the top of it)	4	AC power supply fan
2	AC power supply LEDs	5	AC power inlet
3	DB-25 alarm connector	6	AC power supply handle

Figure 2-13 shows the AC power supplies LEDs and DB connector.

Figure 2-13 Cisco ASR 1004 Router AC Power Supply LEDs and DB -25 Alarm Connector

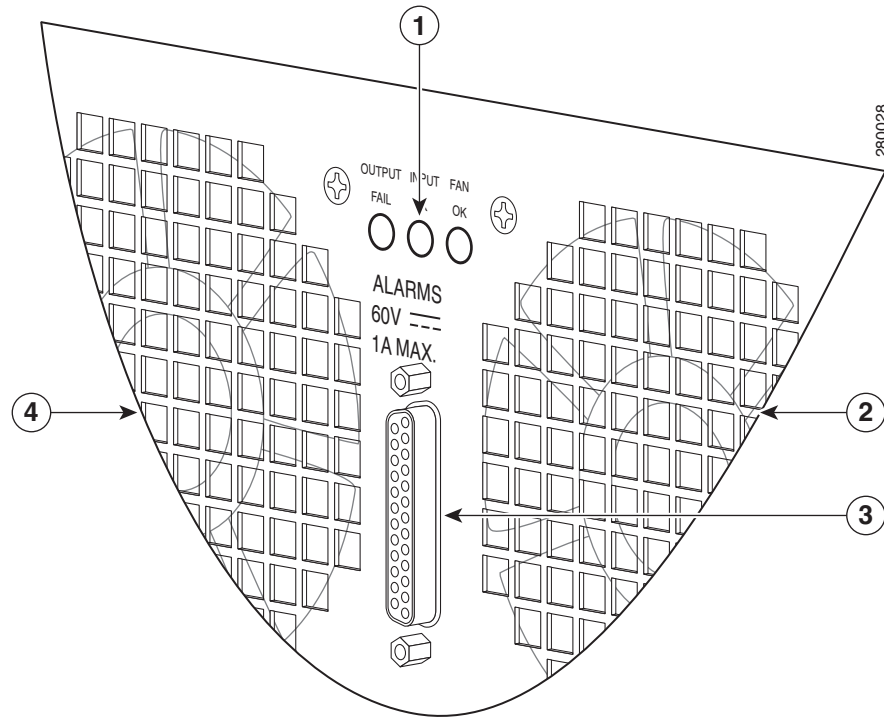

1	AC power supply LEDs	3	DB-25 alarm connector
2	Power supply fan	4	AC power supply fan

Table 2-13 describes the AC power supply LEDs on the Cisco ASR 1004 Router.

Table 2-13 Cisco ASR 1004 Router AC Power Supply LEDs and Connector

LED Label	LED	Color	Description
INPUT OK	Power supply activity	Green	LED illuminates green to signal that the AC power supply input voltage is greater than 85V.
		None	If LED is not illuminated, then the AC input voltage is less than 70V or the power supply is turned off. For an AC input voltage between 70V and 85V, the INPUT OK LED can be either on, off, or flashing

LED Label	LED	Color	Description
FAN OK	Bi-color LED indicates fan status	Green	LED illuminates green when all fans are operational.
		Red	The LED illuminates red when a fan failure is detected.
OUTPUT FAIL	Power supply activity	Red	LED is red and turned off to signal that the AC output voltages are within the normal operating range; output voltage between the minimum and maximum limits will not create an output fail alarm, and output voltages below the minimum or above the maximum will create an output fail alarm.  When you turn the power supply on, the red LED is illuminated for two to three seconds for testing LED operation before going off.

## Cisco ASR Router 1004 DC Power Supply

This section provides information about the DC power supplies on the rear of the Cisco ASR 1004 Router. For the maximum branch circuit for the DC power supply module, see [Table 2-7](#).

The DC power supply operates within specification from –48 VDC to –60 VDC continuously. The Cisco ASR 1004 Router has two of the same type power supplies in power supply slot 0 and power supply slot 1. The power supply slot numbers are on the left side of the chassis and the power supplies are located on the floor of the chassis.

The DC power supply input connector is a terminal block style that will allow crimp type lugs accepting up to AWG #8 wire. The terminal block is compliant to all safety agencies and electrical requirements of the supply. The terminal block accepts two-hole lugs (#10 stud) for all connections with center to center spacing of 0.625 inches. A plastic cover goes over the terminal block to prevent accidental contact. The connection order shall be negative (–), positive (+), and GND terminals.

The unit requires a power switch circuit breaker to serve as the main disconnect for the DC input to the power supply ([Table 2-7](#) see for current rating requirements.) The power supply unit is secured into the system chassis with four captive screws mounted on the faceplate.

## Cisco ASR 1004 Router DC Power Supply LEDs and Connector

[Figure 2-14](#) shows the DC power supplies at the rear of the Cisco ASR 1004 Router. The Cisco ASR 1004 Router supports up to two power supplies. The power supply LEDs and connectors on the rear of the chassis are described in the [Table 2-14](#).



Figure 2-14 Cisco ASR 1004 Router DC Power Supply

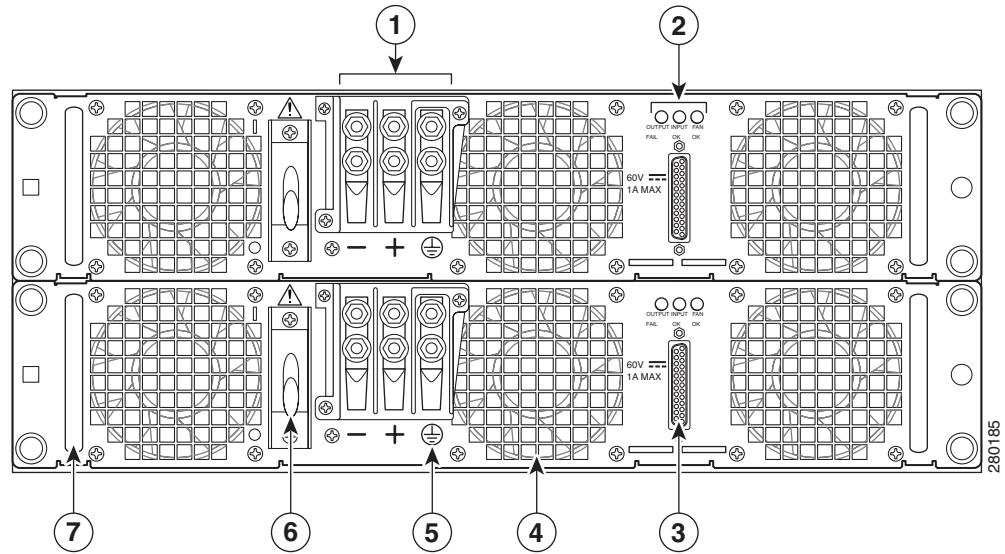

1	DC power supply terminal and plastic cover	5	Earth grounding symbol
2	DC power supply LEDs	6	DC power supply On (I) /Off (O) switch
3	DB-25 alarm connector Power supply ground lugs (+ and -)	7	DC power supply handle
4	DC power supply fan		

Table 2-14 describes the LEDs on the Cisco ASR 1004 Router DC power supply.

Table 2-14 Cisco ASR 1004 Router DC Power Supply LEDs

LED Label	LED	Color	Description
INPUT OK	A bi-color LED indicates presence of input voltage	Green	LED illuminates green to signal that the DC power supply input voltage is greater than -43.5VDC at turn-on and remains green down to -39VDC.
		Amber	The LED illuminates amber when the input voltage (falls below -39VDC) and indicates that there is still a voltage present (voltage on the terminal block). The LED remains amber and is active to around 20V +/-5V. The LED is not illuminated if the input is below -15V.

LED Label	LED	Color	Description
FAN OK	A bi-color LED indicates power supply fan status	Green	The LED illuminates green when all fans are operational.
		Red	The LED illuminates red when a fan failure is detected.
OUTPUT FAIL	Power supply activity	Red	<p>When the LED is off, it signals that the DC output voltage are within the normal operating range. Output voltage between the minimum and maximum limits will not create an output fail alarm, and output voltages below the minimum or above the maximum will create an Output Fail alarm.</p> <p>When you turn the power supply on, the red LED illuminates for two to three seconds to test LED operation before going off.</p>

### DC Power System Input for Cisco ASR 1004

The DC power supply operates within specification from  $-40.5\text{VDC}$  to  $-72\text{VDC}$  continuously once the the power supply DC input turn on threshold of  $-43.5\text{V}$  has been reached. [Table 2-20](#) shows the common input ranges for *reference* only.

**Table 2-15 Cisco ASR 1004 Router DC Power System Input**

Voltage Range (VDC)	Minimum	Nominal	Maximum
Domestic	$-40.5$	$-48$	$-56$
International	$-55$	$-60$	$-72$

### AC/DC Power System Output for Cisco ASR 1004

The power supply output tolerance is defined in [Table 2-16](#) under all combinations of line variation. Total system consumption per power supply should not exceed 735 W.

**Table 2-16 Cisco ASR 1004 Router Power System Output Voltage and Current**

Output Voltage	+12 VDC	+3.3 V
Minimum	11.80 VDC	3.20 VDC
Nominal	12.00 VDC	3.30 VDC
Maximum	12.20 VDC	3.40 VDC
Output Current		
Minimum	2.80 A	0.10 A
Maximum	61.44A	3.125 A

## Power Supplies for Cisco ASR 1002 Router

The Cisco ASR 1002 Router supports an AC or DC power supply:

- [Cisco ASR 1002 Router AC Power Supply, page 2-27](#)—The AC power supply operates between 85VAC and 264VAC. AC power input is an IEC 320-type power inlet, 15A service connector. The AC input side contains a front panel with provisions for mounting screw, two built-in handles to extract the power supply, three status LEDs, and fans for power supply and system cooling.

- [Cisco ASR 1002 Router DC Power Supply, page 2-29](#)—The DC power supply operates between –40.5VDC and –72VDC. Three-position euro-style terminal block, with labeled connections for – (–48/60 V input) and + (–48/60 V Return) and the GND symbol for grounding. The DC input side contains a front panel with provisions for mounting screw, built in handles to remove the power supply, three status LEDs, and fans for power supply and system cooling.

#### Cisco ASR 1002 Router Power Supply Fans

Cisco ASR 1002 Router system level cooling is provided by two 12 VDC type fans in each power supply module. The fans in each module provide system cooling back-up in the event of a single fan failure. In addition, the fans in each of the power supplies can be powered from a single supply when only one unit is operational. The airflow direction is front to back.



#### Warning

---

**This product relies on the building's installation for short-circuit (overcurrent) protection. Ensure that the protective device is rated not greater than: AC power supplies for the Cisco Aggregation Services Routers: 120 VAC, 20A U.S. maximum. DC power supplies for the Cisco ASR 1006 Router: 50A U.S. maximum; Cisco ASR 1004 Router: 40A U.S. maximum; Cisco ASR 1002 Router: 30A U.S. maximum.**  
Statement 1005

---

## Cisco ASR 1002 Router AC Power Supply

This section provides information about the AC power supplies on the rear of the Cisco ASR 1002 Router.

The Cisco ASR 1002 Router system level cooling is provided by two 12 VDC type fans in each of the two power supply modules. The fans in each module are intended to provide system cooling back-up in the event of a single fan failure. In addition, the fans in each of the power supplies can be powered from a single supply when only one unit is operational. The airflow direction is front to back. A single blind-mate connector located on the inlet side of these modules mates with a connector mounted on back side of the midplane.

Guide pins located at the rear of these modules help center locate the modules and reduce stress to the midplane and module mounted connectors. Two captive screws (tool operated latches) are provided on the modules face plate (chassis rear) to secure these modules into the chassis.

### Cisco ASR 1002 AC Power Supply LEDs and Connector

[Figure 2-15](#) shows the AC power supplies at the rear of the Cisco ASR 1002 Router. The Cisco ASR 1002 Router supports up to two power supplies. The power supply LEDs and connectors on the rear of the chassis are described in [Table 2-10](#).

Figure 2-15 Cisco ASR 1002 Router AC Power Supply

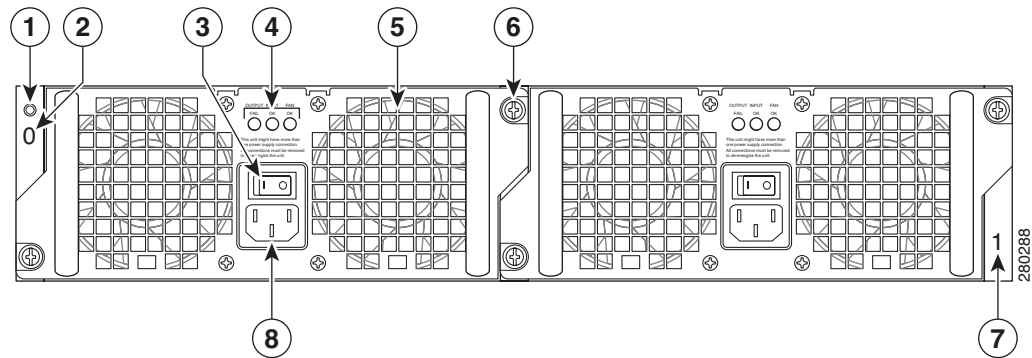

1	AC power supply ESD socket	5	AC power supply fan
2	AC power supply slot number 0	6	AC power supply captive installation screw
3	AC power supply On (I) /Off (O) switch	7	AC power supply slot number 1
4	AC power supply LEDs	8	AC power supply inlet

Table 2-17 describes the AC power supply LEDs on the Cisco ASR 1002 Router.

Table 2-17 Cisco ASR 1002 Router AC Power Supply LEDs

LED Label	LED	Color	Description
INPUT OK	Power supply activity	Green	LED illuminates green to signal that the AC power supply input voltage is greater than 85V.
		None	If LED is not illuminated, then the AC input voltage is less than 70V or the power supply is turned off. For an AC input voltage between 70V and 85V, the INPUT OK LED can be either on, off, or flashing
FAN OK	Bi-color LED indicates fan status	Green	LED illuminates green when all fans are operational.
		Red	The LED illuminates red when a fan failure is detected.
OUTPUT FAIL	Power supply activity	Red	LED is red and turned off to signal that the AC output voltages are within the normal operating range; output voltage between the minimum and maximum limits will not create an output fail alarm, and output voltages below the minimum or above the maximum will create an output fail alarm.

## AC Power System Output Voltage Alarm Range for Cisco ASR 1002

The AC power supply output voltage alarm occurs when the output voltage is below the low end of the minimum or above the high end of the maximum limits shown in [Table 2-18](#).

**Table 2-18 Cisco ASR 1002 Router AC Power Supply Output Voltage Alarm Range**

	Minimum	Maximum
<b>12 V</b>	10.0 to 11.2V	12.8 to 13.8 V
<b>3.3 V</b>	2.6 to 3.0V	None

## Cisco ASR 1002 Router DC Power Supply

This section provides information about the DC power supplies on the rear of the Cisco ASR 1002 Router. The recommended branch circuit breaker for the Cisco ASR 1002 Router DC power supply is 30Amp. Use an AWG #10 maximum wire gauge on the 30Amp circuit. The maximum branch circuit for the DC power supply module must not exceed 30Amp.

The Cisco ASR 1002 Router has two of the same type power supplies in power supply slot 0 and power supply slot 1. The power supply slot numbers are on the left side of the chassis and the power supplies are located on the floor of the chassis. The power supply switch is a Standby switch and is not considered a disconnect.

The DC input connector is a euro-style terminal block. The largest size gauge of wire that the front panel euro-terminal block can accept is AWG #10 wire. The terminal block is compliant to all safety agencies and electrical requirements of the power supply. Use the tie wraps to dress the input cable wires; there are two tie wrap tabs on the DC power supply.

The DC power supply unit is secured into the system chassis with two captive screws mounted on the faceplate.

## Cisco ASR 1002 Router DC Power Supply LEDs and Connector

[Figure 2-16](#) shows the DC power supplies at the rear of the Cisco ASR 1002 Router. The Cisco ASR 1002 Router supports up to two power supplies. The power supply LEDs and connectors on the rear of the chassis are described in the [Table 2-19](#).

Figure 2-16 Cisco ASR 1002 Router DC Power Supply

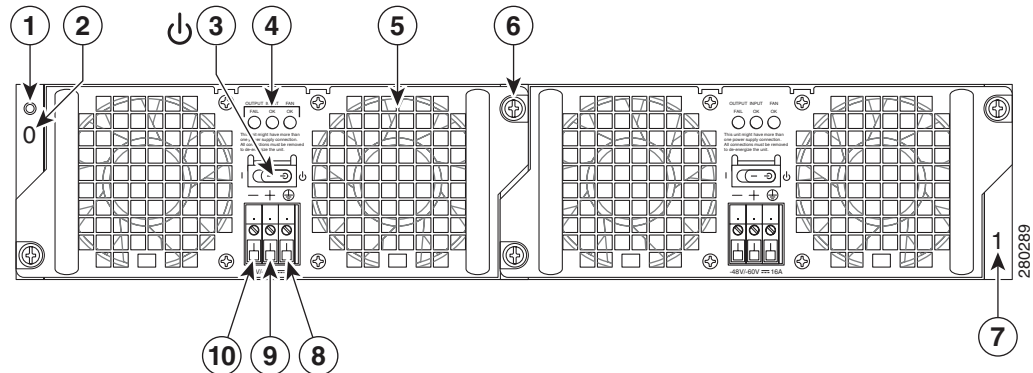

1	DC power supply ESD socket	6	DC power supply captive installation screw
2	DC power supply slot 0 label	7	DC power supply slot 1 label
3	DC power supply switch Standby/On (I) (standby symbol is a broken circle with a vertical line through the top of it)	8	Negative ground lead
4	DC power supply LEDs	9	Positive ground lead
5	Fan	10	Earth ground lead

Table 2-19 describes the LEDs on the Cisco ASR 1002 Router DC power supply.

Table 2-19 Cisco ASR 1002 Router DC Power Supply LEDs

LED Label	LED	Color	Description
INPUT OK	A bi-color LED indicates presence of input voltage	Green	LED illuminates green to signal that the DC power supply input voltage is greater than -43.5VDC at turn-on and remains green down to -39VDC.
		Amber	The LED illuminates amber when the input voltage (falls below -39VDC) and indicates that there is still a voltage present (voltage on the terminal block). The LED remains amber and is active to around 20V +/-5V. The LED is not illuminated if the input is below -15V.
FAN OK	A bi-color LED indicates power supply fan status	Green	The LED illuminates green when all fans are operational.
		Red	The LED illuminates red when a fan failure is detected.
OUTPUT FAIL	Power supply activity	Red	When the LED is off, it signals that the DC output voltage are within the normal operating range. Output voltage between the minimum and maximum limits will not create an output fail alarm, and output voltages below the minimum or above the maximum will create an Output Fail alarm.  When you turn the power supply on, the red LED illuminates for two to three seconds to test LED operation before going off.

## DC Power System Input for Cisco ASR 1002

The DC power supply operates within specification from  $-40.5\text{VDC}$  to  $-72\text{VDC}$  continuously once the power supply DC input turn on threshold of  $-43.5\text{V}$  has been reached. Table 2-20 shows the common input ranges for *reference* only. The DC power input connector is a euro-style terminal block with three wires, one positive, one negative, and one grounding wire.

**Table 2-20 Cisco ASR 1002 Router DC Power System Input**

Voltage Range (VDC)	Minimum	Nominal	Maximum
Domestic	-40.5	-48	-56
International	-55	-60	-72

## DC Power System Output for Cisco ASR 1002

The DC power supply output tolerance is defined in Table 2-21 under all combinations of DC input line variation. Total system power consumption should not exceed 470 watts or output rating of each power supply.



### Note

Two power supplies are used for redundant operation. System total power consumption shall never exceed rating of one power supply to maintain redundancy.

**Table 2-21 Cisco ASR 1002 Router DC Power System Output Voltage and Current**

Output Voltage	+12 VDC	+3.3 V
Minimum	-11.80 VDC	-3.20 VDC
Nominal	-12.00 VDC	-3.30 VDC
Maximum	-12.20 VDC	-3.40 VDC
Output Current		
Minimum	-2.0 A	-0.10 A
Maximum	-39 A	-3.125 A

